



Eck-Kamin 51/52/52 lifting doors (easy-lift)

State: 11.02.2015



BRUNNER[®]
made in germany

Dimension sheet | **Eck-Kamin 51/52/52 lifting doors (easy-lift)**

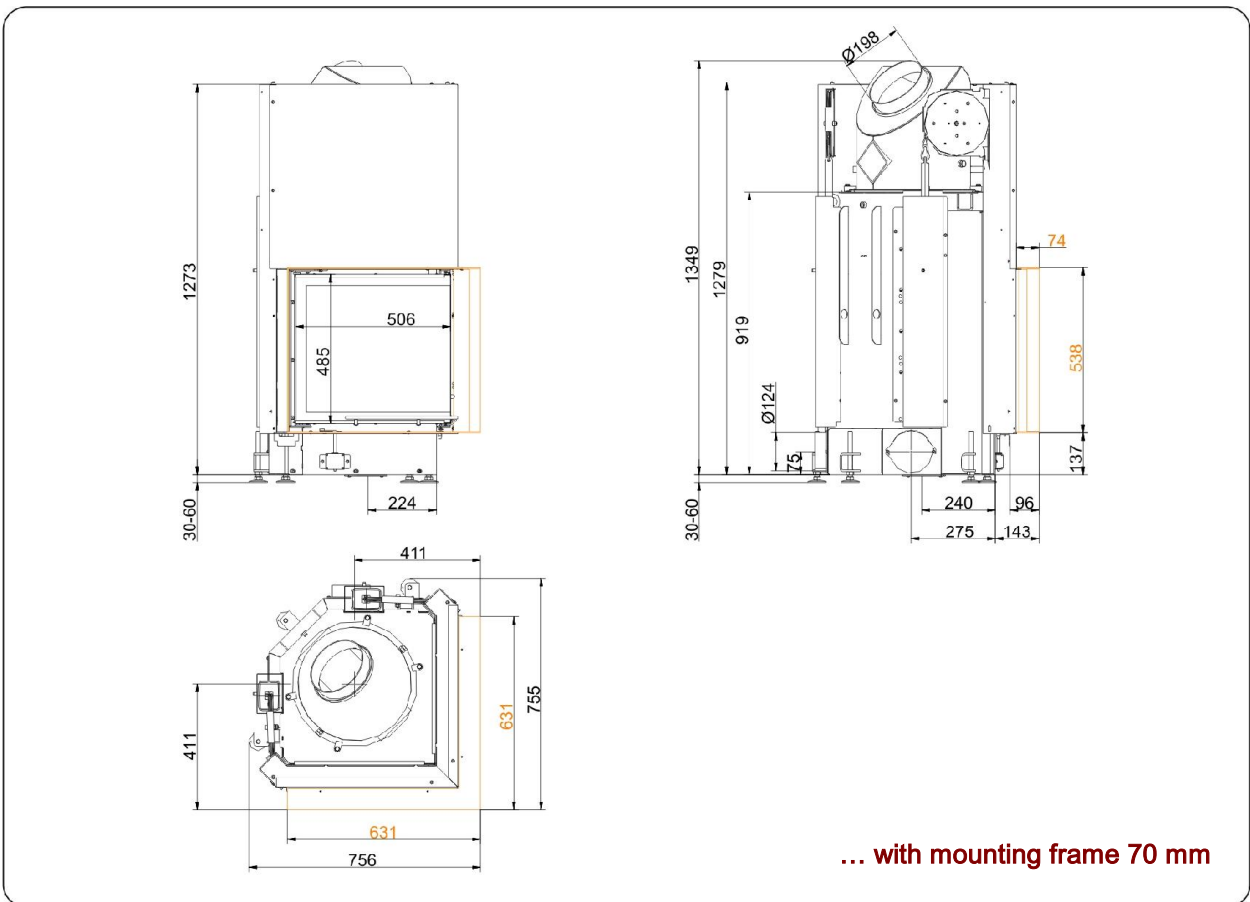
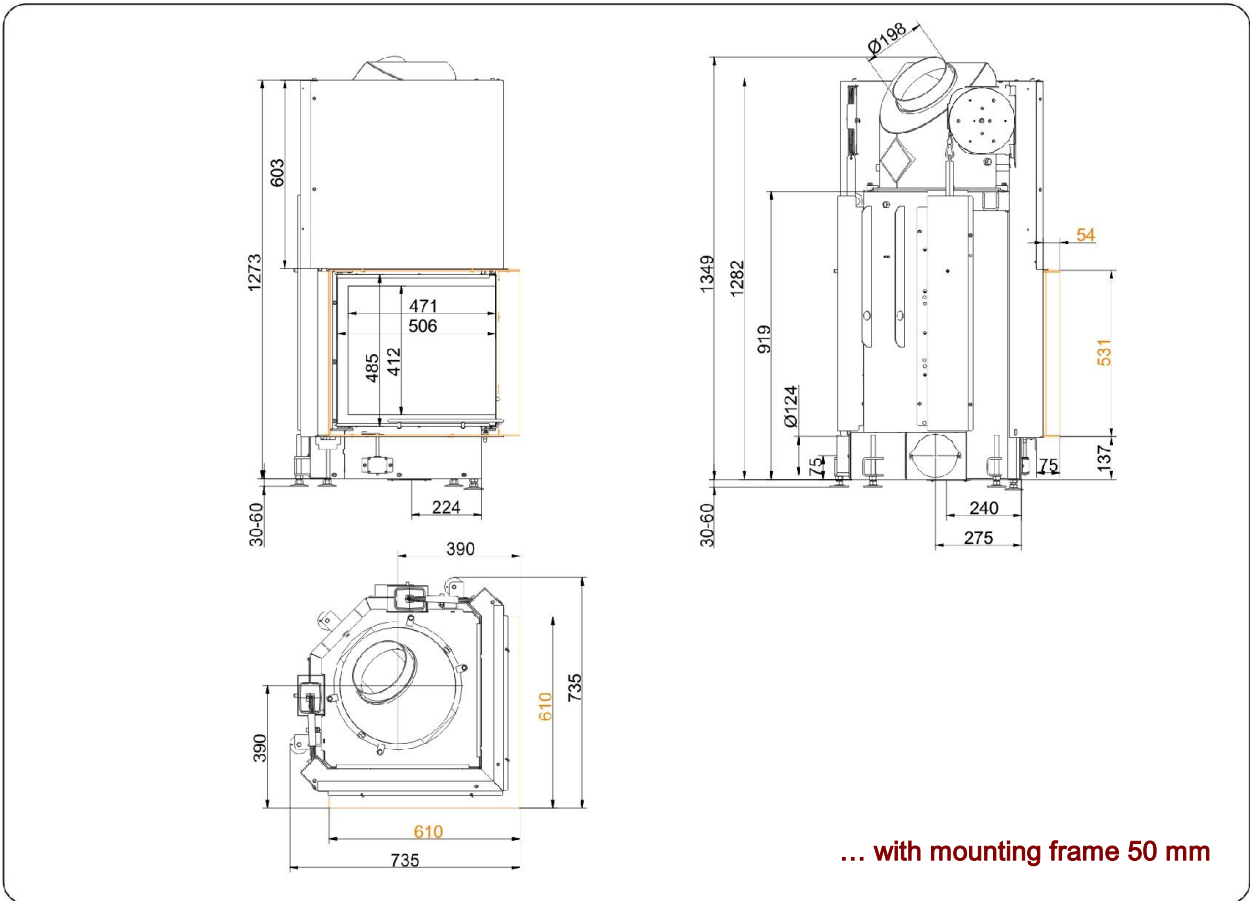

We suggest for CAD planing Palette CAD. Permanent updated drawings: www.brunner.de
 Frames / front versions are marked colored.

Planning and installation

Eck-Kamin 51/52/52

Tested according to		EN 13229 W	EN 13229 WA	EN 13229 W
Values measured at		nominal load	accumulation	open door
Suitable for all construction types according to rules		OK	OK	OK
Data for functional demonstration				
Rated heat power	kW	10	-	-
Firewood consumption	kg/h	3	5	3
Combustion performance	kW	13	22	13
Flue gas mass flow	g/s	12	21	81
Outlet temperature (before heating surface)	°C	-	340	-
Flue gas temperature after				
attached steel smoke hood	°C	210	246	116
1 x adjoining cast iron radiator (GNF10)	°C	-	124	-
6 x accumulation rings (MAS) ¹⁾	°C	-	210	-
2 m adjoining ceramic accumulator ²⁾	°C	-	180	-
1,4 m accumulation stones (MSS)	°C	-	180	-
water boiler	°C	-	-	-
Necessary supply pressure	Pa	13	15	8
Combustion air consumption	m ³ /h	30	50	200
Combustion air connection Ø	mm	125	125	-
Heat distribution				
Insert / heating surface	%	25 / 30	25 / 30	- / -
Glass (single / double)	%	45 / -	45 / -	- / -
Boiler	%	-	-	-
Vent cross-section ⁴⁾				
Supply air	cm ²	500 / 100 / 300	500 / 100 / 300	-
Warm air	cm ²	500 / 100 / 300	500 / 100 / 300	-
Minimal oven surface for closed construction type				
Surface giving off heat	m ²	4,0	4,0	-
Space inside oven chamber				
Distance to oven chamber wall	cm	8	8	8
Distance to floor	cm	15	15	15
Heat insulation without / with ³⁾ air gratings				
Wall	cm	14 / 10	14 / 10	14 / 10
Floor	cm	2 / 2	2 / 2	2 / 2
Ceiling	cm	16 / 12	16 / 12	16 / 12
Insulation of additional fire door DHT	cm	-	-	-
Brick lining of protected walls	cm	10	10	10
Weight				
Fireplace + burning chamber	kg		162 + 54	
meets requirement limit values for				
Germany / Austria / Switzerland / Norway		1.BImSchV (Stufe 2) / 15a BVG (2015) / LRV / NS 3059		

1) Throttle flap recommended

2) Approximate value, must be calculated eventually

3) Values with air gratings, stove casing is heat conducting

4) for firebox / flue gas pipe / metallic reheating surface

Ulrich Brunner GmbH
 Zellhuber Ring 17 -18
 D-84307 Eggenfelden
 Phone: +49 / (0)87 21 / 7 71-0
 Fax: +49 / (0)87 21 / 7 71-100
 info@brunner.eu | www.brunner.eu



BRUNNER products are offered and sold only by qualified dealers and service centres.
 Subject to technical and assortment changes. Errors excepted. (02/15)